

Features

- Compression valve
- Annealed vertical tube with supply flange
- 1/2" NPT connection with flange
- Four-arm handle stop

Material

- Brass



Codes/Standards







ASME A112.18.1/CSA B125.1

KOHLER® One-Year Limited Warranty

See website for detailed warranty information.

Available Colors/Finishes

Color tiles intended for reference only.

Color	Code	Description
	CP	Polished Chrome
	SN	Vibrant™ Polished Nickel
	PB	Vibrant™ Polished Brass
	BN	Vibrant™ Brushed Nickel
	BV	Vibrant™ Brushed Bronze
	2MB	Vibrant™ Brushed Moderne Brass

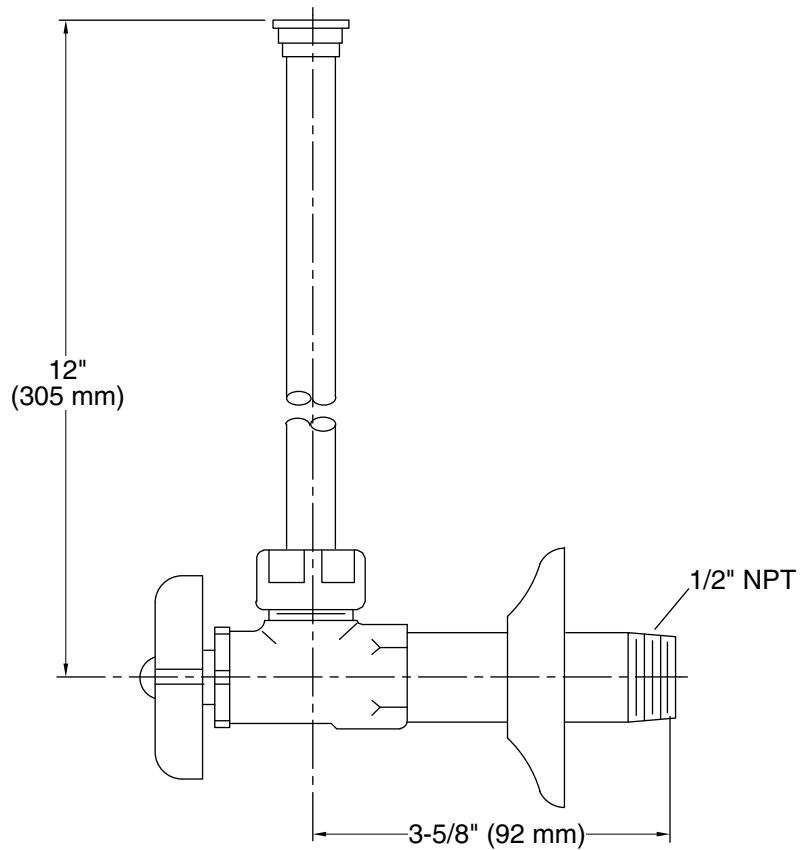

Technical Information

All product dimensions are nominal.

Notes

Install this product according to the installation guide.